

# Battery Powered Friends of Hue Switch

70100041

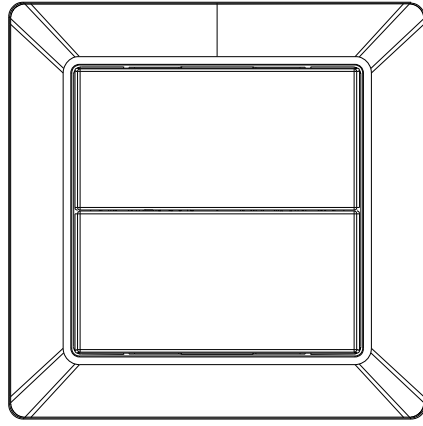

**Important: Read All Instructions Prior to Installation**  
Function introduction



Front side

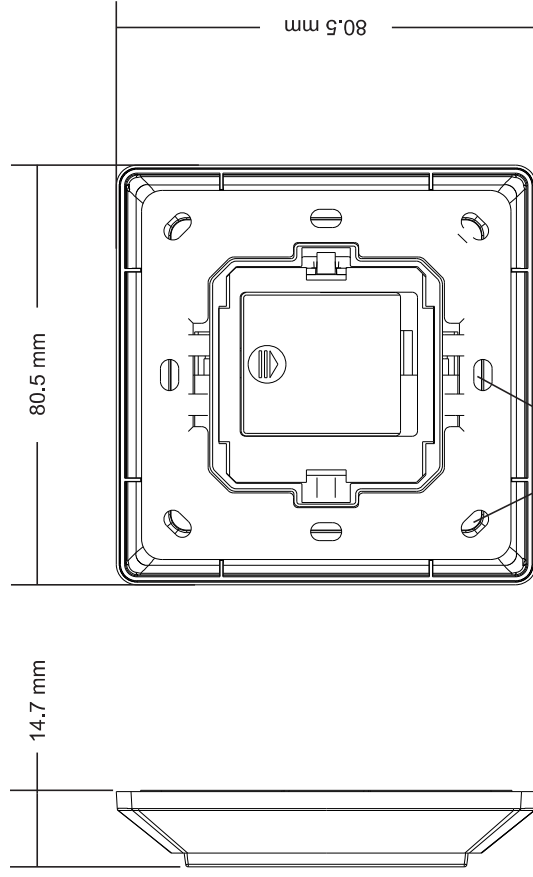

The remote control can be fixed on the wall with 3M glue or screw.

Back side

## With Glass Frame

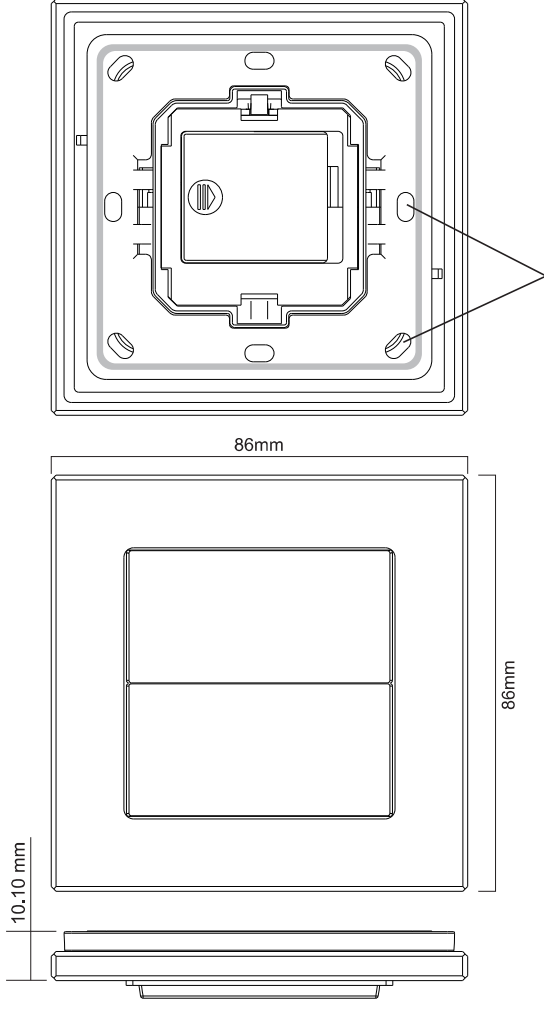

The remote control can be fixed on the wall with 3M glue or screw.

### Product Data

Switch Type	Friends of Hue Switch
Transmission Range	10-30m (typical)
Radio Frequency	2.4GHz
Power Supply	3V(1xCR2430 battery)
Buttons	4
Dimensions	80.5x80.5x14.7mm / 86x86x14mm
Operating Temperature	-20 °C ~ +45 °C
Working Humidity	10% ~ 95% RH non-condensing
Waterproof Grade	IP20
Warranty	5 years

### Product Description

The Friends of Hue switch is a wireless transmitter that communicates with Philips Hue bridge. The switch uses a CR2430 battery that powers a built-in transmitter. This transmitter sends wireless radio signals that are used to remotely control the Philips Hue system.

The switch can be configured through Hue App after added to the Hue bridge. It enables to control designated light devices in 2 designated rooms with 4 buttons. Functions of the 4 buttons can be configured separately through Hue App. The configurable functions includes ON/OFF, dim up/dim down, and system preset scene control.

### Safety & Warnings

- DO NOT expose the device to moisture.

## Operations

### 1. Add the Switch to Hue Bridge

Step 1: configure your Hue Bridge correctly and add light devices to the Hue Bridge through Hue App as instructed.

Step 2: tap "Accessory setup" on "Settings" page, then tap "Add accessory", then tap "Friends of Hue switch".

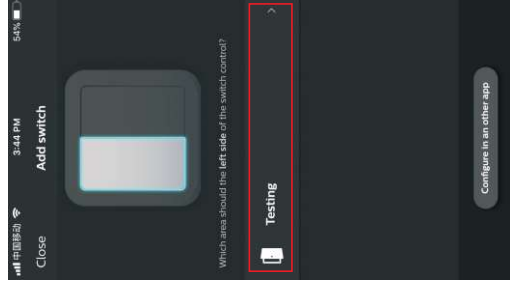
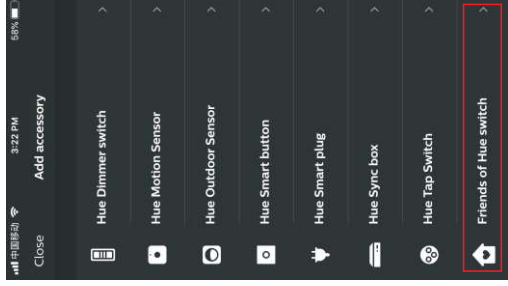
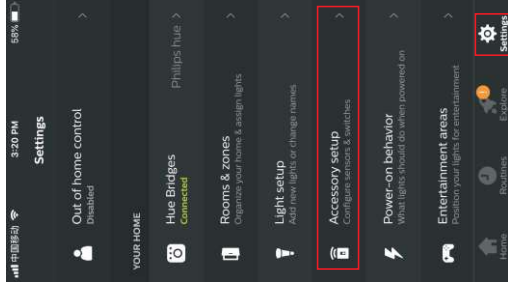

### 3. Configure the Switch through Hue App

Step 1: once added successfully, you can use the system suggested setting or configure the switch as per your preferences. Just tap "Done" to use suggested setting, or tap "change settings" to configure as instructed. 4 buttons can be configured one by one separately. Tap the button area to select the button to be configured.

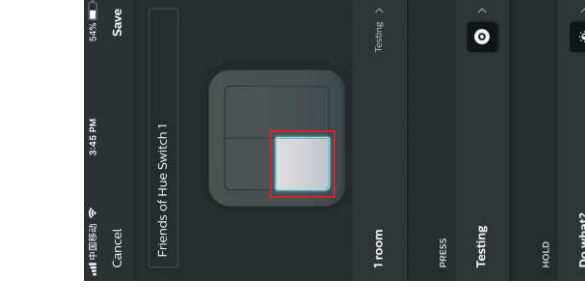
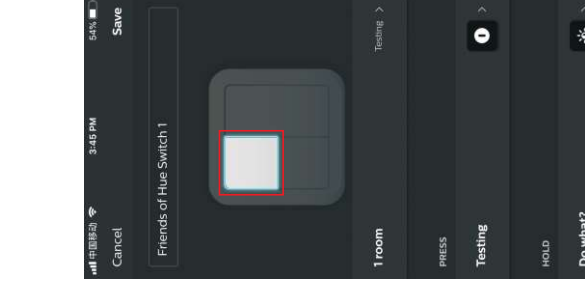
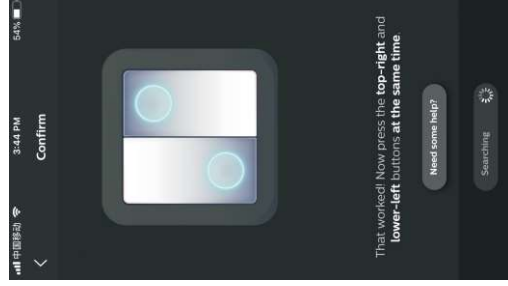
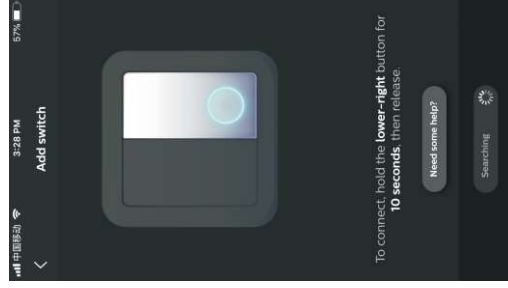
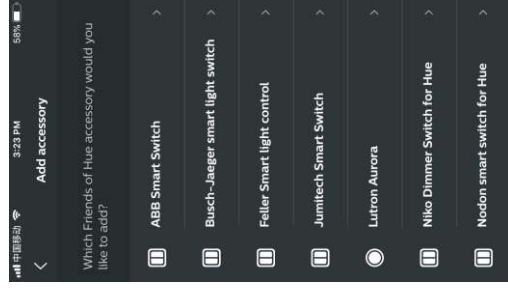

### 2. Select designated room/rooms to control

Step 1: Tap to select a room to be controlled by left side on the switch, then right side.

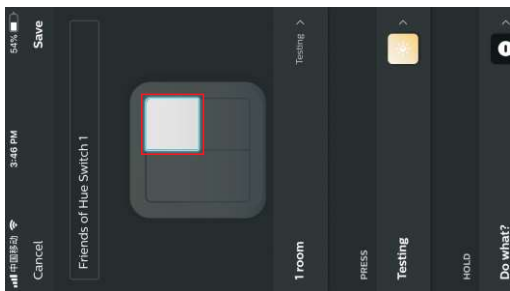
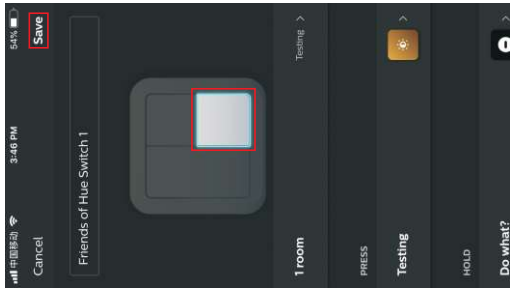
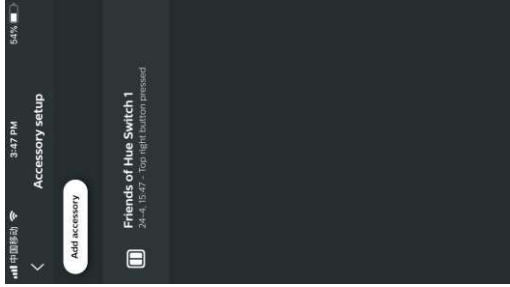

#### 4. Control the Light Devices in the Selected Room/Rooms with the Switch

After configured successfully, tap "save" at upper right corner to save the settings. Then you can use the switch to control the light devices in the selected room/rooms.

#### Installation

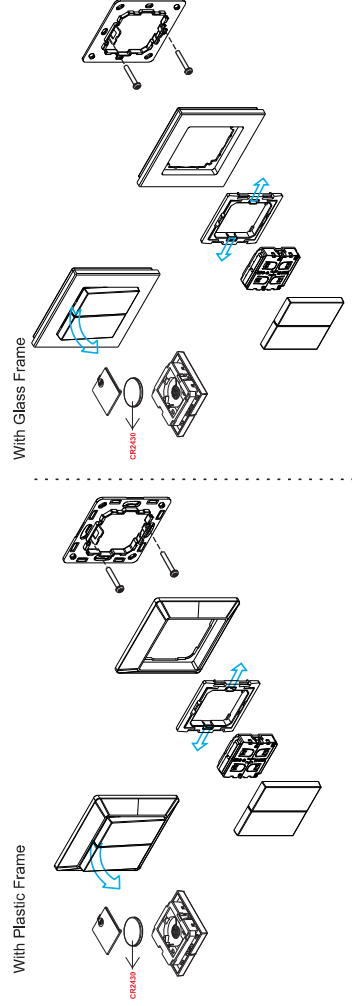

The key part of this controller is a universal, extremely rotary standard switch element that can be integrated in numerous frames by different manufactures as below list:

BEKER	S1, B1, B3, B7 glass
GIRA	Standard55, E2, Event, Esprit
JUNG	A500, Aplus
MERTEN	M-smart, M-Atc, M-Plan