

Shelly® dimmer

Smart WiFi LED Dimmer USER GUIDE

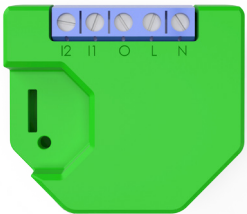

LEGEND:

- I2 - Switch input 2 for on/off/dimming
- I1 - Switch input 1 for on/off/dimming
- O - Output
- L - Line input (110-240V)
- N - Neutral input (Zero)

The Shelly® smart WiFi dimmer by Allterco Robotics is intended to be installed directly to your lights in order to control and dim the light. It is intended to be mounted into a standard in-wall console, behind the light switches or other places with limited space. Shelly may work as a standalone device or as an accessory to a home automation controller.

SHELLY DIMMER CANNOT BE CONNECTED AND OPERATE A FAN. DOING SO MAY CAUSE DAMAGE TO THE UNIT OR FAN, INCLUDING CAUSING A FIRE!!!

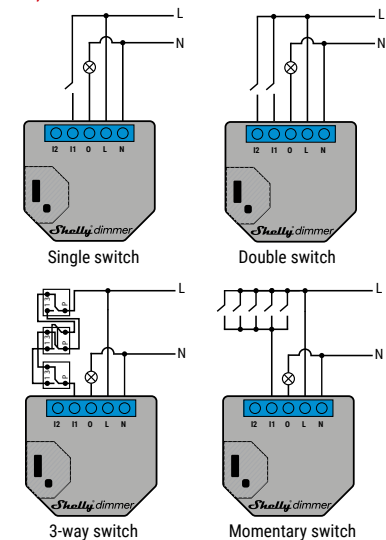

Specification

Power supply: 110-240V ±10% 50/60Hz AC	Working temperature: from 0°C to 35°C	Dimensions (HxWxL): 42 x 36 x 14 mm
Operational current: 0.25-1.7A	Radio signal power: 1mW	Electrical consumption: < 1,5 W
Device temperature protection: 105°C	Radio protocol: WiFi 802.11 b/g/n	Supported light types: * Incandescent and * Halogen light sources: 1-220W * Dimmable LED : 50-200VA / 1W - 200W
Complies with EU standards: • RE Directive 2014/53/EU • LVD 2014/35/EU • EMC 2004/108/WE • RoHS2 2011/65/EU	Frequency: 2400 - 2500 MHz	Resistive-inductive loads ferromagnetic transformers: 50-150VA
	Operational range (depending on local construction): • up to 50 m outdoors • up to 30 m indoors	

Introduction to Shelly®

Shelly® is a family of innovative Devices, which allow remote control of electric appliances through mobile phone, PC or home automation system. Shelly® uses WiFi to connect to the devices controlling it. They can be in the same WiFi network or they can use remote access (through the Internet). Shelly® may work standalone, without being managed by a home automation controller, in the local WiFi network, as well as through a cloud service, from everywhere the User has Internet access. Shelly® has an integrated web server, through which the User may adjust, control and monitor the Device. Shelly® has two WiFi modes - access Point (AP) and Client mode (CM). To operate in Client Mode, a WiFi router must be located within the range of the Device. Shelly® devices can communicate directly with other WiFi devices through HTTP protocol. An API can be provided by the Manufacturer. Shelly® devices

may be available for monitor and control even if the User is outside the range of the local WiFi network, as long as the WiFi router is connected to the Internet. The cloud function could be used, which is activated through the web server of the Device or through the settings in the Shelly Cloud mobile application.

The User can register and access Shelly Cloud, using either Android or iOS mobile applications, or any internet browser and the web site: <https://my.Shelly.cloud/>.

Technical Information

- Control through WiFi from a mobile phone, PC, automation system or any other Device supporting HTTP and/or UDP protocol.
- Microprocessor management.
- Shelly may be controlled by an external button/switch.

CAUTION! Danger of electrocution. Mounting the Device to the power grid has to be performed with caution.

CAUTION! Do not allow children to play with the button/switch connected to the Device. Keep the Devices for remote control of Shelly (mobile phones, tablets, PCs) away from children.

Installation Instructions

CAUTION! Danger of electrocution. The mounting/installation of the Device should be done by a qualified person (electrician).

CAUTION! Do not connect the Device to appliances exceeding the given max load!

CAUTION! Connect the Device only in the way shown in these instructions. Any other method could cause damage and/or injury.

CAUTION! Before beginning the installation please read the accompanying documentation carefully and completely. Failure to follow recommended procedures could lead to malfunction, danger to your life or violation of the law. Allterco Robotics is not responsible for any loss or damage in case of incorrect installation or operation of this Device.

CAUTION! Use the Device only with power grid and appliances which comply with all applicable regulations, short circuit in the power grid or any appliance connected to the Device may damage the Device.

RECOMMENDATION: The Device may be connected to and may control electric circuits and appliances only if they comply with the respective standards and safety norms.

RECOMMENDATION: The Device may be connected to and may control electric circuits and light sockets only if they comply with the respective standards and safety norms.

AWARENESS: If the Device is not connected to the supported light types, the dimming functionality may not be present. However, you will still be able to turn on and off your lights.

Initial Inclusion

Before installing/mounting the Device ensure that the grid is powered off (turned down breakers).

Connect the Shelly to the power grid following the wiring scheme above (fig.1). You may choose if you want to use Shelly with the Shelly Cloud mobile application and Shelly Cloud service. You can also familiarize yourself with the instructions for Management and Control through the embedded Web interface.

Control your home with your voice

All Shelly devices are compatible with Amazon Echo and Google Home.

Please see our step-by-step guide on:

<https://shelly.cloud/compatibility/Alexa>
<https://shelly.cloud/compatibility/Assistant>



MOBILE APPLICATION FOR MANAGEMENT OF SHELLY®



Shelly Cloud gives you opportunity to control and adjust all Shelly® Devices from anywhere in the world.

You only need an internet connection and our mobile application, installed on your smartphone or tablet.

To install the application please visit Google Play (Android - fig. 2) or App Store (iOS - fig. 3) and install the Shelly Cloud app.



fig. 2

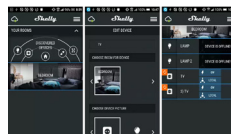
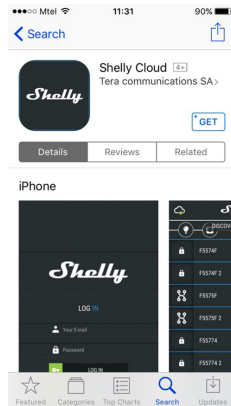

fig. 3



Registration

The first time you load the Shelly Cloud mobile app, you have to create an account which can manage all your Shelly® devices.

Forgotten Password

In case you forget or lose your password, just enter the e-mail address you have used in your registration. You will then receive instructions to change your password.

WARNING! Be careful when you type your e-mail address during the registration, as it will be used in case you forget your password.

After registering, create your first room (or rooms), where you are going to add and use your Shelly devices.

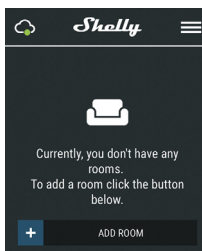

Shelly Cloud gives you opportunity to create scenes for automatic turning on or off of the Devices at predefined hours or based on other parameters like temperature, humidity, light etc. (with available sensor in Shelly Cloud).

Shelly Cloud allows easy control and monitoring using a mobile phone, tablet or PC.

Device Inclusion

To add a new Shelly device, install it to the power grid following the Installation Instructions included with the Device.

Step 1

After the installation of Shelly and the power is turned on, Shelly will create its own WiFi Access Point (AP).

WARNING! In case the Device has not created its own WiFi network with SSID like **shellydimmer-35FA58** check if you have connected Shelly correctly by the wiring schemes. If you do not see an active WiFi network with SSID like **shellydimmer-35FA58**, reset the Device. If the Device has been powered on, you have to power it off and on again. After turning the power on, you have 60 seconds to press 5 consecutive times either switch connected I1/I2. Or if you have physical access to the Device, press and hold the reset button for 10 seconds. When the LED indicator starts to flash quickly, release the button. Shelly should return to AP Mode. If not, please repeat or contact our customer support at: support@Shelly.cloud

Step 2

Choose "Add Device".

In order to add more Devices later, use the app menu at the top right corner of the main screen and click "Add Device". Type the name (SSID) and password for the WiFi network, to which you want to add the Device.

Step 3

If using iOS: you will see the following screen:

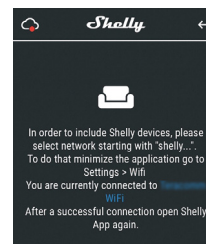

Press the home button of your iPhone/iPad/iPod. Open Settings > WiFi and connect to the WiFi network created by Shelly, e.g. **shellydimmer-35FA58**.

If using Android: your phone/tablet will automatically scan and include all new Shelly devices in the WiFi network that you are connected to.



Upon successful Device Inclusion to the WiFi network you will see the following pop-up:

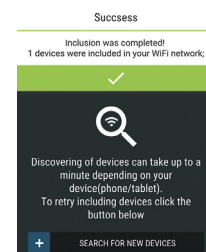

Step 4:

Approximately 30 seconds after discovery of any new Devices on the local WiFi network, a list will be displayed by default in the "Discovered Devices" room.



Step 5:

Enter Discovered Devices and choose the Device you want to include in your account.



Step 6:

Enter a name for the Device (in the Device Name field). Choose a Room, in which the Device has to be positioned. You can choose an icon or add a picture to make it easier to recognize. Press "Save Device".

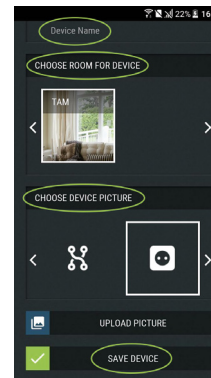

Step 7:

To enable connection to the Shelly Cloud service for remote control and monitoring of the Device, press "YES" on the following pop-up.

